

Starwade Metal Products, Inc.
 6868 State Route 305 PD Box 10
 Hartford, Ohio 44424
 Phone: 800-826-5243 Fax: 1-330-772-3307
 www.tankstore.com

Tank For Stationary Use Only

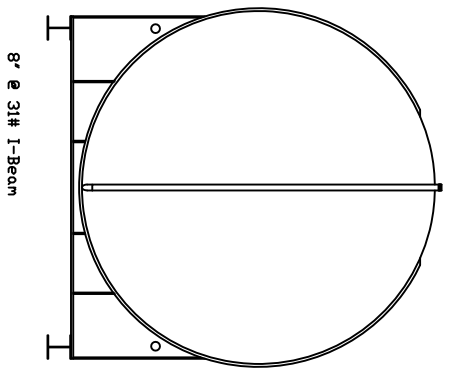

Capacity	20,000 Gallons	Heads	Primary	1/4"	Paint Ext.	White Urethane
Design	Doublewall Beamskid	Shell Primary	1/4"	Paint Int.		
Code	UL 142 Flameshield	Heads Secondary	1/4"	Weight Empty	29,250 lbs.	
Test Pres.	5 PSI	Shell Secondary	7 Ga.	Rev.#	Date:	

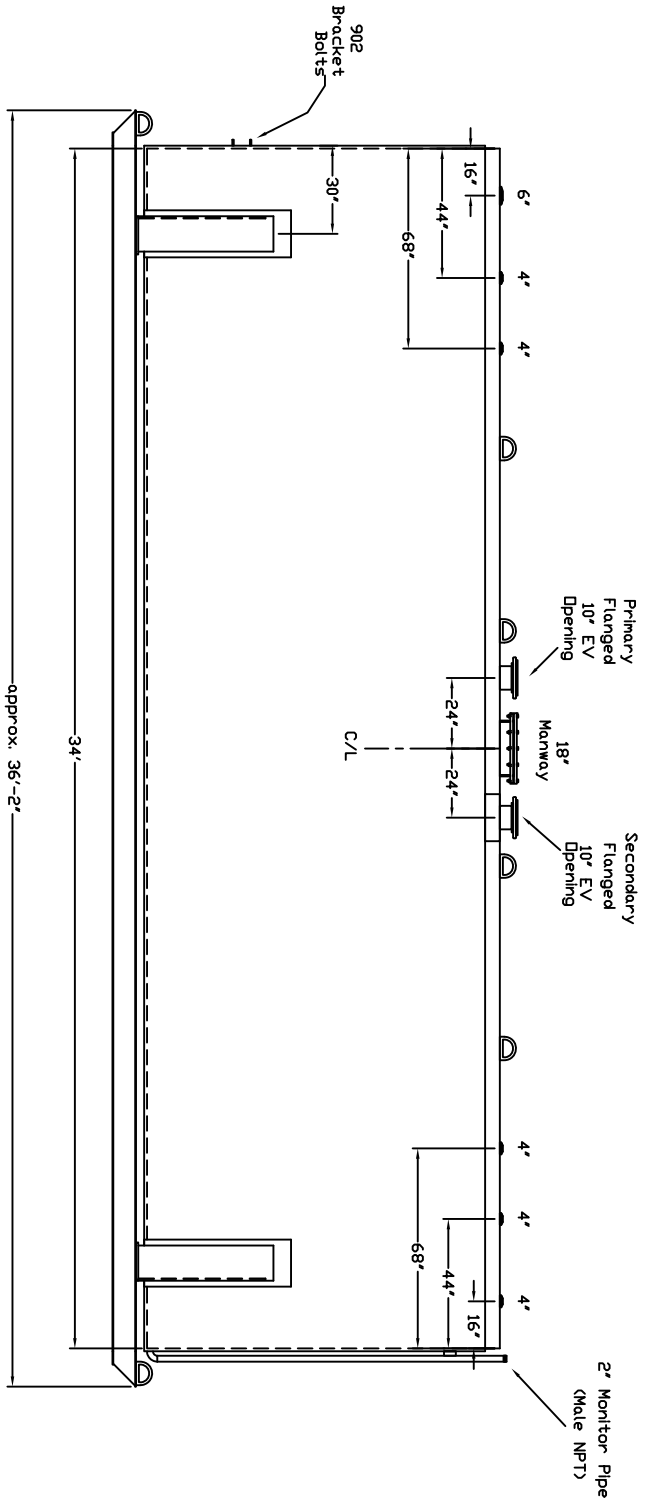

Customer: _____ Drg. Date: _____ Drawing Approved By: _____

Quoted Lead Times Begin Upon Receipt of signed Approved Drawing, Which Must be Returned Before Production Can Begin.